

# Distribution of the Analog or Digital FM Composite Multiplex Signal across IP Networks

Junius Kim and Keyur Parikh  
 GatesAir  
 Mason, Ohio

**Abstract** - Wide area IP networking is ubiquitous, low cost, and flexible and with the emergence of high bandwidth connections it is possible to transport analog or digital FM composite multiplex (MPX) signals across these networks. The FM MPX signal has numerous components with a set of requirements for signal processing and timing recovery. We review various FM processing architecture chains and examine where various elements can be located and where telecom networks are needed for signal transport. The quality of transport of a wideband analog or digital FM MPX signal over an IP network with typical network impairments presents challenges with regards to delay and data integrity. Various strategies can be deployed which can mitigate the effect of these network impairments. We explore these strategies, including differences in transport requirements between analog and digital FM MPX signals and the tradeoffs they present with respect to bandwidth, scalability, and delay.

At the receiver, the stereo pilot tone is used as a timing reference to generate the 38 kHz sub-carrier for the stereo demodulation process.

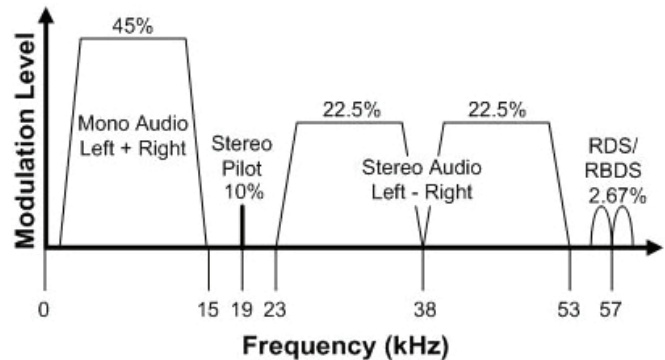

FIG 2 FM MPX FREQUENCY SPECTRUM

## BACKGROUND

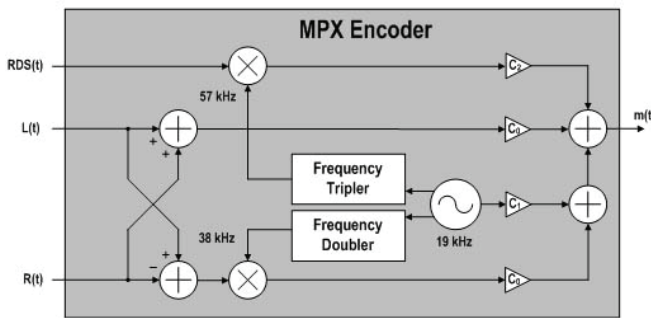

FIG 1 FM MPX ENCODER PROCESS

In FM broadcasting, a stereo multiplexed signal (MPX) is generated from the process shown in Figure 1. The signal contains multiple components such as the left plus right audio, the left minus right audio, a 19 kHz stereo pilot tone, and a Radio Data System (RDS) signal. The left minus right audio is modulated onto a 38 kHz subcarrier (locked to the 2nd harmonic of the stereo pilot tone). After up-conversion, the sub-carrier is suppressed so the L-R audio is modulated using Double Side Band Suppressed Carrier (DSBSC). RDS data is digital modulated onto a 57 kHz subcarrier (locked to the third harmonic of the stereo pilot tone) and used to carry low bit rate (1187.5 bps) RDS metadata. In addition, other services such as Subsidiary Communications Authorization (SCA) channels may be generated which are modulated onto higher subcarriers, 67 kHz and 92 kHz. These services are low bandwidth (less than 8 kHz) and typically are audio services.

The MPX composite signal frequency spectrum is shown in Figure 2 along with approximate modulation levels. The frequency spectrum bandwidth varies depending on components carried, but at a minimum, with RDS, it is 60 kHz and can be up to 100 kHz with two SCA channels.

## THE FM TRANSMISSION CHAIN

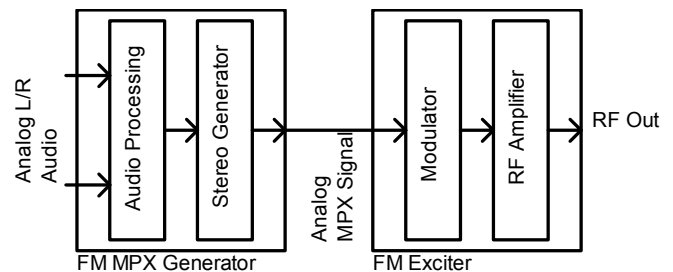

FIG 3 FM SIGNAL PROCESSING CHAIN

Figure 3 shows a common FM processing chain. The audio channels undergo audio processing which performs functions such as over-shoot limiting, frequency limiting (typically to less than 15 kHz), and pre-emphasis. After audio processing, the stereo generation or MPX encoding process occurs. Any or all of these processes can be performed in the digital or analog domain. The resultant analog MPX baseband signal feeds into an FM exciter.

To reduce analog processing, the stereo generation process can be performed in the digital domain. Such digital MPX processing can produce a digital discrete time

representation of an MPX signal formatted for interconnection using AES/EBU at 192 kHz sample rate. AES/EBU encapsulates a 24-bit left and right channel audio sample into two 32-bit sub-frames. The remaining 8-bits of the sub-frame are used for metadata, parity checking, and synchronization information. The two sub-frames are combined into one 64-bit frame. MPX over AES is carried on one of the two AES/EBU channels. Due to the Nyquist frequency, MPX over AES is band-limited to approximately less than 80 kHz so the third FM sub-carrier at 92 kHz is not carried.

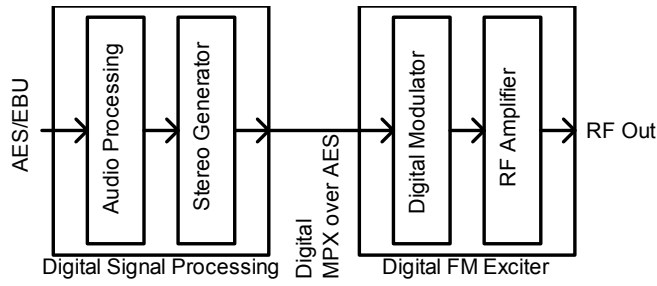

FIG 4 ALL DIGITAL FM SIGNAL PROCESSING CHAIN

Figure 4 shows an all-digital FM processing chain with baseband audio in the digital domain (AES/EBU) feeding into an audio processor and MPX over AES feeding the FM exciter. The MPX signal is now in the digital domain and embodies the components necessary for FM broadcast.

### MPX OVER AN STL

A FM Studio-Transmitter Link (STL) using digital telecommunications such as T1/E1 or IP can have several topologies as shown in Figure 5. One common topology is where left and right audio are transported from the studio to far-end transmitter site using an audio codec. The stereo generation is done at the transmitter site. Other FM baseband information such as RDS data and SCA audio can be transported in the same audio codec assuming it supports all these data interfaces. Another possible STL topology is transport of the analog MPX signal itself using an MPX codec. This codec performs analog to digital conversion (ADC) at the studio and digital to analog conversion (DAC) at the transmitter.

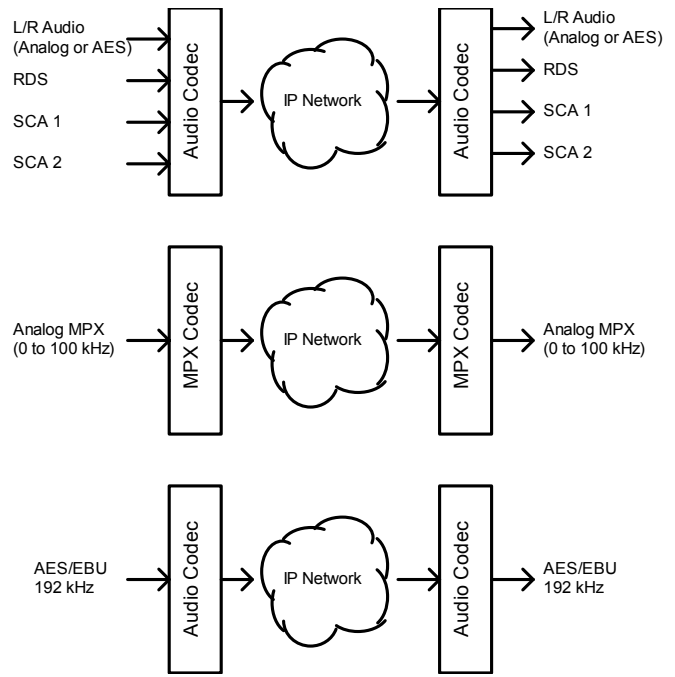

FIG 5 STL TOPOLOGIES

The MPX over AES discrete time signal can also be transported on some audio codecs. In this case the codec has to support the 192 kHz sampling rate and ideally transport the information transparently (no sample rate conversion or audio compression).

STL transport of MPX can have several advantages over baseband audio transport. The MPX generation process (stereo generation, RDS, and SCA modulation) is centralized and controlled at the studio site. In the case of multiple transmitter sites, the MPX generation is done once rather than being distributed out to the transmitter sites. With MPX over AES, a complete digital processing chain is preserved with no additional analog processes or sample rate conversion processes required.

With MPX over AES, the STL bandwidth requirements can be high. For example, AES/EBU at 192 kHz with one channel has a data rate of 6.144 Mb/s (32-bits per sample). The bandwidth can be reduced if the codec transports only the 24-bit audio samples and regenerates the AES/EBU parity, synchronization data, and metadata at the transmitter site. With one channel of 24-bit samples the data rate is 4.608 Mb/s.

The MPX signal can also be transported with an analog MPX type codec where the analog MPX signal is digitized and processed in the codec. The analog MPX codec can offer advantages in terms of flexibility. Such a codec can support different sampling word sizes (16, 20, 24-bit), different sampling bandwidths to transport just the stereo audio, or the stereo audio plus RDS, or stereo audio plus RDS plus SCA channels. This type of flexibility can adapt the codec to best suit the bandwidth of the STL network connection. This is in contrast to MPX over AES which supports a fixed word size and fixed sampling rate. In addition, analog MPX is compatible with most existing FM plant infrastructure while

MPX over AES is a relatively new operating standard possibly requiring acquisition of compatible equipment.

### MPX SIGNAL PROCESSING

The analog MPX codec signal processing requires preservation of the signal quality throughout the entire STL chain. The maximum achievable dynamic range for a digital representation of an analog signal using uniform quantization is 6 dB per bit. So 16-bit quantization can provide 96 dB of dynamic range.

In the ADC process, the analog input signal must be band-limited or filtered prior to sampling to avoid artifacts caused by aliasing. Additionally, over-sampling is used to deprecate the requirements of the front-end analog filter since its frequency domain poles and zeros can be placed well above the sampling frequency. Subsequent decimation filtering can be performed entirely in the digital domain by DSP functions utilizing finite impulse response (FIR) filters. FIR filters are linear phase which means the phase response of the filter is a linear (straight-line) function of frequency. This results in the delay through the filter being the same at all frequencies. Therefore, the filter does not cause "phase distortion" or "delay distortion". The lack of phase/delay distortion is an important advantage of FIR filters over analog filters.

In the DAC conversion process we again want to perform over-sampling through digital interpolation filters followed by analog filtering to remove the sampling clock artifact. The over-sampling process scales down the requirements of the analog filter and it's inherent phase distortion.

A change in gain over the 0 to 53 kHz region can negatively affect stereo channel separation. This is due to the stereo demodulation process, where gain change can cause the left audio generation process of  $2L = (L+R) + (L-R)$  and right audio generation process of  $2R = (L+R) - (L-R)$  to not completely cancel out the undesired channel. We need a gain change flatness of 0.05 dB across the 0 to 53 kHz frequency spectrum for stereo separation to be greater than 50 dB. The effect of loss of stereo separation with gain change applies to phase shift as well. Non-linear phase response will cause the demodulation process to not completely cancel out the unwanted channel.

The ADC process gain change over sampling frequency ( $f_s$ ) for a MPX codec is shown in Figure 6 using over-sampling and FIR filtering. The figure shows a high stop-band attenuation (>100 dB) and a very flat frequency response close to the Nyquist frequency.

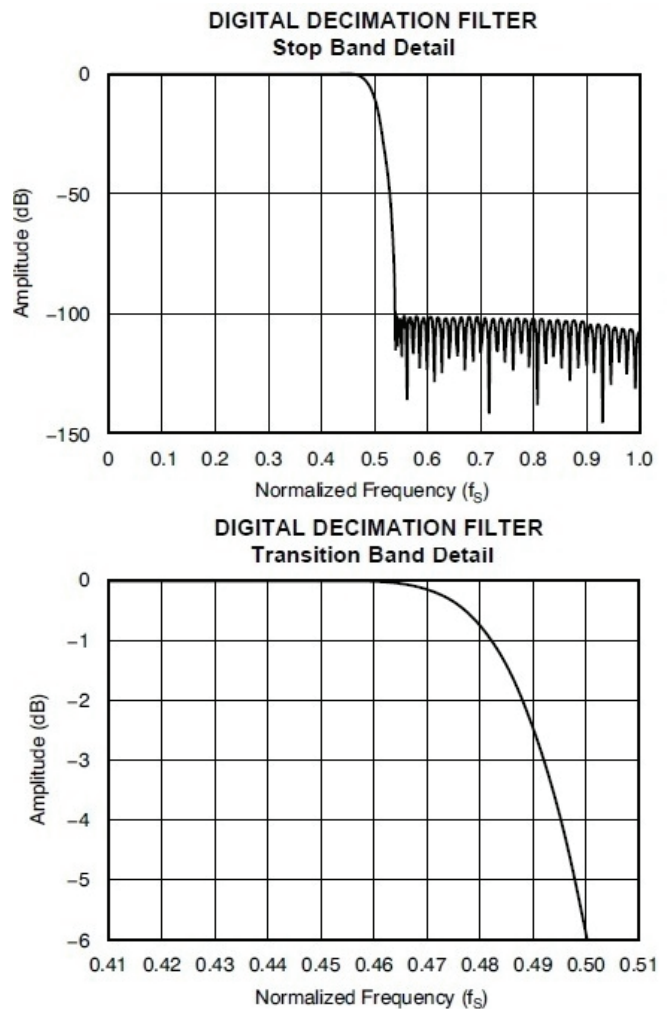

FIG 6 ADC FREQUENCY RESPONSE WITH OVER-SAMPLING AND FIR FILTERING

### MPX TIMING RECOVERY

In FM broadcasting, the tolerance of the 19 kHz pilot tone is +/-100 PPM. For a MPX STL system, the timing recovery process of the MPX signal at the decoder must be better than this. For an analog MPX codec, the timing recovery process provides the sample rate clock to the DAC process at the decoder which ideally should be identical to the ADC sample rate clock at the encoder. The timing recovery process for MPX over AES is similar. Although the AES/EBU signal natively carries an embedded clock, this clock information is effectively lost during in the STL driven coding and decoding processes. The MPX over AES timing recovery process regenerates the embedded AES/EBU 192 kHz sampling rate clock at the decoder.

Usage of GPS has enabled an effective method for synchronizing timing. GPS receivers can deliver a precise common timing reference to geographically diverse sites. Using GPS, the ADC and DAC sample rate clocks can effectively be locked together in the analog MPX codec. When using MPX over AES, GPS can reference the AES

clock in the MPX over AES stereo generator and the AES clock at the MPX over AES STL decoder.

Other methods for clock transport such as Precision Time Protocol (PTP) and AES/EBU can be used. PTP is intended for local systems that cannot bear the cost of a GPS receiver at each node, or where GPS signals are inaccessible. AES/EBU has an embedded clock. If a system provides a coordinated method of synchronizing AES clock infrastructure at encode and decode sites, then the ADC and DAC sample rate clocks can be referenced to AES/EBU through the use of a phase lock loop (PLL). In the case of MPX over AES, the outgoing AES/EBU 192 kHz sampling clock at the decoder can be referenced using from an incoming AES/EBU signal. Note that such a signal does not need to be 192 kHz sampling, but can be any common sampling rate (32, 44.1, 48 kHz) and the PLL can up-convert that to 192 kHz.

If a method of common timing (GPS, PTP, or AES/EBU) is not available then in the case of the analog MPX codec, the ADC and DAC sample rate clocks are “loosely” locked. The MPX decoder receiving the MPX data stream can recover the ADC sample rate clock by examining the characteristics of its stream recovery buffer or jitter buffer (Figure 7) and drive the DAC clock as to keep the jitter buffer fill level constant. However, the characteristic frequency response of this process can be very low. In an IP based STL system, this frequency is correlated with the IP packet rate and can be 10 Hz or lower. So it’s important the timing recovery process algorithm be optimized with the appropriate filters and response characteristics as well as being bandlimited to not exceed the stereo pilot tone tolerance.

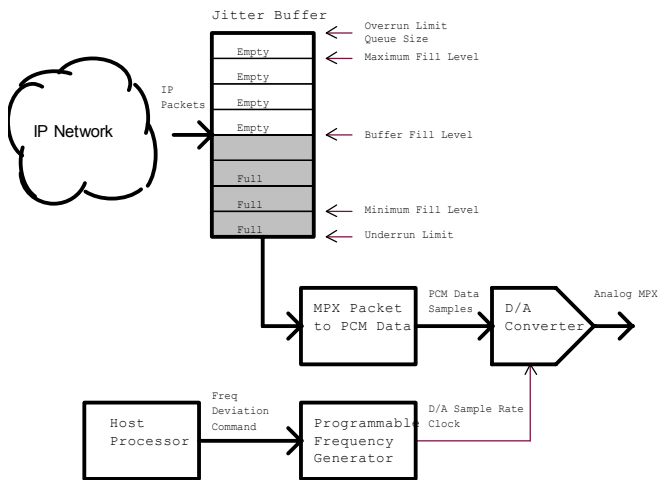

FIG 7 TIMING RECOVERY

**RF SINGLE FREQUENCY SIMULCASTING**

RF single frequency simulcasting uses multiple, geographically disperse RF transmitters operating on the same carrier frequency, modulating the same program material. By using multiple transmitters, geographic RF coverage area is expanded. The region where a RF receiver can pick up multiple signals feeds from multiple transmitters is the overlap region. In an audio broadcasting application, a RF receiver in this region will simultaneously demodulate

audio programming carried on multiple RF carriers. In this region, the modulation should be closely phase aligned from the multiple transmitters to provide the best receive quality.

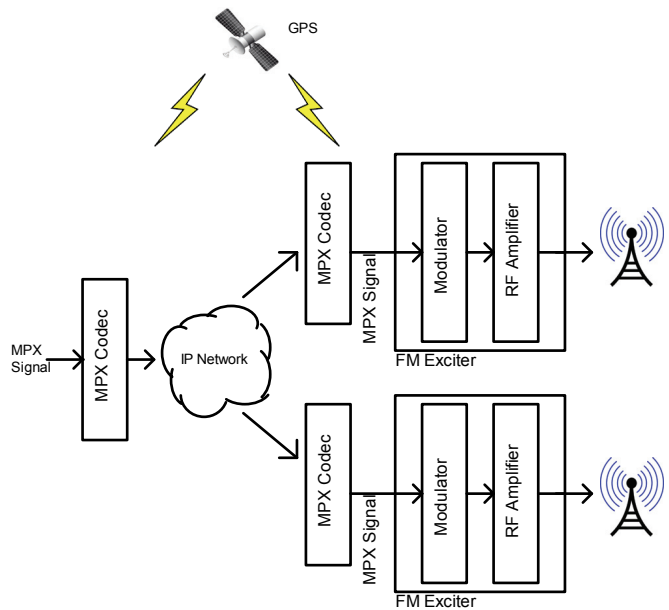

FIG 8 FM SIMULCAST SYSTEM

MPX vs baseband audio transport over an STL can offer advantages when deploying a RF simulcasting system (Figure 8). In a baseband audio transport STL scenario, the audio codec process undergoes a precision delay process unique to each geographically diverse transmitter site so that each FM stereo generator is presented the audio “in-phase” with respect to all the other FM generators in the simulcast system [1]. However, other MPX sub-carrier components (RDS and SCA) may not undergo the same precision delay process resulting in out-of-phase RF transmission for these components. In an MPX transport STL scenario, the entire MPX can undergo a precision delay process so all components are in-phase with each other.

In the case where RDS data is different for each transmitter site, for example the program identification PI code, then the RDS data would need to be uniquely regenerated at each site and the advantage of in-phase RDS is obviated.

**MPX STL NETWORKING CONSIDERATIONS**

The wide area network (WAN) payload bandwidth requirements for transporting an MPX signal varies based on the type of MPX signal being transported. MPX over AES has a payload data rate of 4.602 Mb/s if AES/EBU overhead information (synchronization, metadata, parity, etc.) is not transported. This MPX transport contains stereo audio, RDS, and one SCA channel.

The analog MPX signal has more flexibility in the payload bandwidth because of settable options for sampling rate and sample size (or resolution). The sampling rate

selection is made based on the services needed to be carried across the WAN. For example, 128 kHz sampling can carry stereo audio and RDS data, 174 kHz sampling can carry an additional SCA channel, and 212 kHz sampling can carry the entire 100 kHz MPX spectrum. Sample size defines the minimum resolution and dynamic range of the signal. Minimally 16 bit samples are used giving 96 dB of dynamic range. Higher resolution sample sizes like 20 and 24 bits may also be used. So depending on the sampling rate and the sample size, the payload bandwidth will vary, Table 1 provides a summary for some possible combinations.

Sample Rate, kHz	Sample Size, bits	Bandwidth, kb/s
128	16	2048
128	24	3072
174	16	2784
174	24	4176
212	16	3392
212	24	5088

TABLE 1 BANDWIDTH FOR MPX DIGITAL SAMPLING

Usage of IP based WAN in broadcast application is rapidly proliferating. IP based networks provide advantages in both reduced operational cost and flexibility for site to site interconnection. The packetized transport of the MPX signal does add additional overhead for packet headers as well as delay associated with the packetization process. The packetization process needs to accumulate samples in a packet buffer prior to transmission. A higher number of samples in a packet results in lower overhead, lower packet rate and higher associated packetization delay. Conversely, the lower number of samples per packet translates to higher packet rate, higher overhead, and lower delay.

The overhead in a packet is associated with the packet header. Real Time Protocol (RTP) over UDP is the most common encapsulation method for transport of real-time media. RTP provides both time stamping and sequence numbering to detect duplicate packets and re-order out-of-order packets. The overhead associated with RTP/UDP headers when transported over IPv4 networks is 40 bytes per packet. Taking the per packet overhead in to account, Figure 9 shows IP network bandwidth required for several MPX transport options based on packet interval and sampling size. For the most bandwidth efficient option, the packet size should be just under the Maximum Transmission Unit (MTU) of the network, for Ethernet this is 1500 bytes.

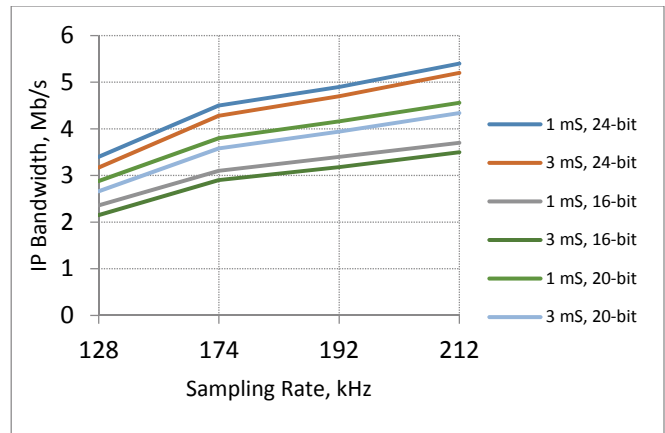

FIG 9 IP BANDWIDTH VS SAMPLING RATE

There is tradeoff between delay and bandwidth efficiency, while keeping the packet size to be less than the MTU of the network path to avoid fragmentation. Fragmentation of IP packets can cause additional delays for re-assembly and traversing Network Address Translation (NAT) devices. In summary, you want to have high packet interval without causing IP fragmentation. This will ensure bandwidth efficiency and reduces the packet rates which helps in avoiding congestion within the IP networking nodes [2].

#### CHALLENGES WITH IP TRANSPORT

The IP based WAN pose various impairments such as packet loss, jitter, loss of network connection, etc. A MPX stream requires constant WAN bandwidth. This is in contrast to audio using lossy compression (AAC, MPEG) in which the encoder can dynamically adjust the bitrate based upon the congestion state of the WAN connection. Packet losses can also have a more pronounced effect on a MPX signal than with audio. For example with compressed audio, concealment techniques can work effectively. The audio codec keeps an ongoing measurement of the spectral image of the audio. The codec already has a time-to-frequency domain transform as part of its perceptual coding function. When a packet loss is detected, a synthetic replacement can be created by using the spectral values in the preceding and subsequent packets [3]. A MPX stream is a lossless PCM encoding method, so no spectral information is computed. A lost MPX packet results in missing data for that packet interval. So when transporting MPX over IP, it is recommended to subscribe to a managed Internet Service Provider (ISP) connection which guarantees bandwidth and keeps packet loss to a minimum. The Packet Delay Variation (PDV) or jitter is less of a concern on managed connection because it can be mitigated by adjusting the size of the receive jitter buffer at the decoder. This adjustment can be either manual or the system can dynamically measure the jitter and adapt the buffer to the appropriate size.

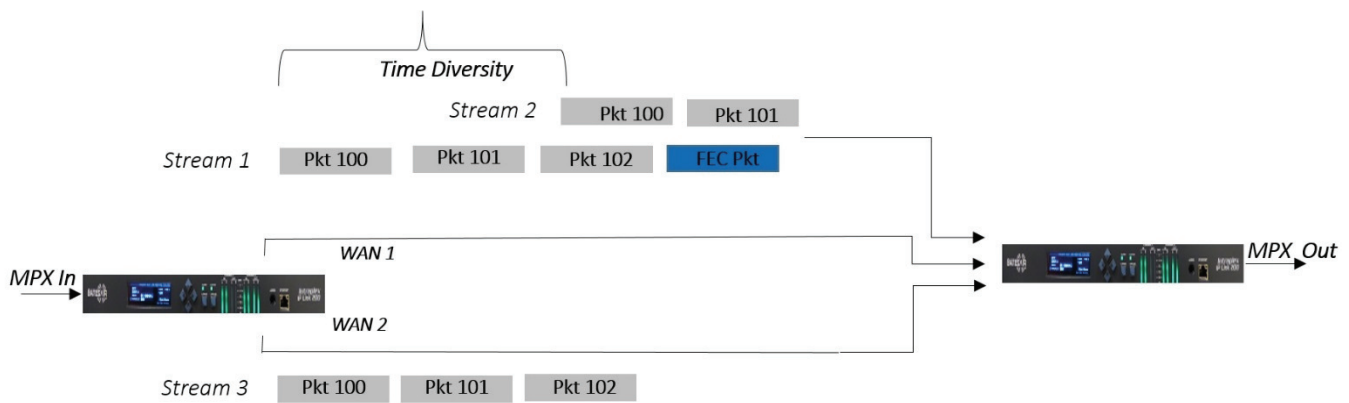

FIG 10 COMBINATION OF DIVERSITY AND FEC PROTECTION

### PACKET LOSS AND CONNECTION LOSS MITIGATION

Even when subscribed to a managed ISP connection, there may be packet losses during certain times that must be dealt with. In addition, due to the complexity of the IP networks, connections are more susceptible to complete path failure when compared to the legacy T1 connection. Packet losses can be reduced using one or more combinations of these recovery techniques: RTP level Forward Error Correction (FEC) and/or redundant streams. Both of these techniques are designed to work in unicast (point-to-point) and multicast (point-to- multipoint) modes of packet transport.

#### RTP Level FEC

	Col 1	Col 2	Col 3	Col 4	F(x)
Row 1	1	2	3	4	XOR(1,2,3,4)
Row 2	5	6	7	8	XOR(5,6,7,8)
Row 3	9	10	11	12	XOR(9,10,11,12)
Row 4	13	14	15	16	XOR(13,14,15,16)
F(x)	XOR(1,5,9,13)	XOR(2,6,10,14)	XOR(3,7,11,15)	XOR(4,8,12,16)	

TABLE 2 4x4 TWO-DIMENSIONAL FEC MATRIX

The RTP level FEC uses the concept of parity packets to recover lost packets at the receiver. It uses a matrix of RTP data packets as shown in Table 2 to generate the FEC packets. FEC packets are created using XOR of rows and columns of data packets for a 2-dimensional FEC. These FEC packets are then sent along with the data packets over the network to the receiver. The ratio of the number of parity packets to data packets is the bandwidth overhead of the FEC scheme. For example, the above scheme generate 8 parity packets for 16 data packets, hence it requires 50% additional bandwidth for the stream. In addition, the receiver needs to buffer up the enough packets based on the size of the matrix to effectively

recover lost packets, hence there is additional delay associated with FEC based packet loss recovery as well. The FEC schemes have shown to be extremely effective for random packet losses, however if the packet losses occur in bursts and if the burst size is greater than number of columns in the FEC matrix, the effectiveness of FEC scheme starts to deteriorate.

#### Redundant Streams

Redundant streams is another technique that can be used for packet loss protection. In this scheme duplicate packets are sent either over independent network paths – network diversity or on the same network using time diversity as shown in the Figure 10. With time diversity, the duplicate packets are sent with a programmable delay between them. Both of these techniques are effective for burst packet losses. However, the network diversity technique has shown to give the best result provided that the paths are truly independent. This technique also provides “hitless” protection against complete failure of a single path. One important point to understand with network diversity is that independent network paths have different delays and jitter characteristics that can be time varying and therefore the implementation must ensure that the receive buffering is always adapted to the optimal size to account for the longest delay and largest jitter among the network paths. When figuring out packet loss protection for a single network, the choice between FEC, time diversity, or combination of the two schemes should be based on analyzing the packet loss patterns. Of course all of these protection techniques assume that the user has adequate network bandwidth and connections along with the network protection capabilities embedded within the MPX codec.

### SUMMARY

The emergence of high bandwidth IP network connections enable the transport of the FM MPX composite signal in an STL. When architecting a STL network topology, transporting a MPX signal vs baseband FM components has advantages in terms centralized distribution and control and being able to effectively perform RF simulcasting of the RDS and SCA.

Two methods of MPX STL transport are digital MPX over AES and analog MPX. Each presents tradeoffs in terms

of required network bandwidth, signal quality, and compatibility with existing FM plant infrastructure. MPX over AES offers the possibility of an all-digital processing chain, while analog MPX can offer greater flexibility and compatibility with legacy equipment. An analog MPX codec signal processing includes ADC and DAC processes. Implementation of high resolution ADC and DAC, over-sampling, decimation, interpolation, and FIR DSP filtering can enable a high quality signal transport with high dynamic range and high stereo separation. In either method of MPX transport, timing recovery must be implemented at the decoder or timing can be derived from a common reference such as GPS.

IP network impairments such as packet loss and jitter must be addressed for robust MPX streaming to be realized. Techniques such as jitter buffering, FEC, time and network diversity with redundant streaming can be utilized. These techniques, if applied in a systematic and intelligent manner can greatly improve the performance of MPX streaming over impaired IP networks.

#### REFERENCES

- [1] Kim, Junius, " RF Simulcasting over IP Networks", NAB Conference, 2009
- [2] Parikh, Keyur and Kim, Junius, " Methods for Mitigating IP Network Packet Loss in Real Time Audio Streaming Applications", NAB Conference, 2014
- [3] Church, Steve and Pizzi, Skip, "Audio over IP", ISBN 978-0-240-81244-1, 2009

#### AUTHOR INFORMATION

**Junius Kim** is a Hardware Engineer with GatesAir in Mason, Ohio. Mr. Kim was a key member of the GatesAir design team responsible for creating the SynchroCast simulcasting system and IP Link, a next generation AoIP codec. His current interests include the architecture and design of robust packet switched based telecommunication systems. Mr. Kim holds a BS and MS in electrical engineering.

**Keyur Parikh** is an Architect and R&D team leader with GatesAir in Mason, Ohio. Mr. Parikh has over 26 years of experience in design and development of communication systems for various applications. Mr. Parikh has been a key member of the GatesAir Intraplex product team since 2005 and is responsible for creating IP networking products for both broadcast and public safety industry. Prior to GatesAir, Mr. Parikh was a product leader for VoIP and mobile data technologies. Mr. Parikh holds a BS in electrical engineering with a master's in communication.

