



# FCC Spectrum Repack

## *The Impact on TV and FM Stations*

April 19, 2016

NAB Show 2016

Featuring  
GatesAir's



Rich Redmond  
Chief Product Officer

# FCC Spectrum Repack The Impact on TV and FM Stations

unleash

anytime

anywhere

connected technologies • immersive experiences • redefined revenue



Rich Redmond  
GatesAir  
Mason, Ohio, USA

# Agenda

- Background – Why the demand
- What is the repack
- What part of the TV facility is impacted?
- How does this impact FM radio
- Transmitter building impacts
- Tower Structure Impacts
- Antenna & Line Impacts
- Potential Interference
- Technical Resource Impacts
- Conclusions

# Why the demand for spectrum

- Mobile data usage grows
- Traditional traffic of web-VOIP becomes smaller portion
- Mobile video consumption consumes almost 3 quarters of usage
- Unicast nature of mobile data drive one to one connection per user – does not scale well for common content
- EMBMS (broadcast LTE) helps but will not meet demand
- More spectrum needed to fuel data growth
- UHF TV spectrum – presented as underused beachfront property

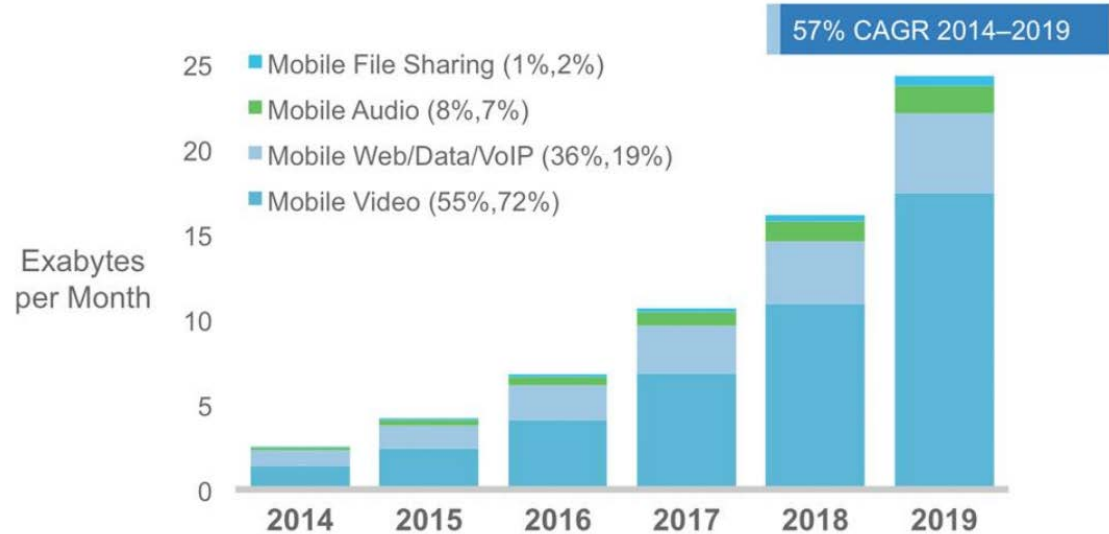

Figures in parentheses refer to 2014, 2019 traffic share.

Source: Cisco VNI Mobile, 2015

Mobile Data Usage Projections

# What is TV Spectrum “Repack”?

- FCC’s Definition of “Repacking”

(Source: <http://wireless.fcc.gov/incentiveauctions/learn-program/repacking.html>)

*“Repacking involves reorganizing television stations in the broadcast television bands so that stations that remain on the air after the incentive auction occupy a smaller portion of the UHF band, thereby freeing up a portion of that band for new wireless services uses.”*

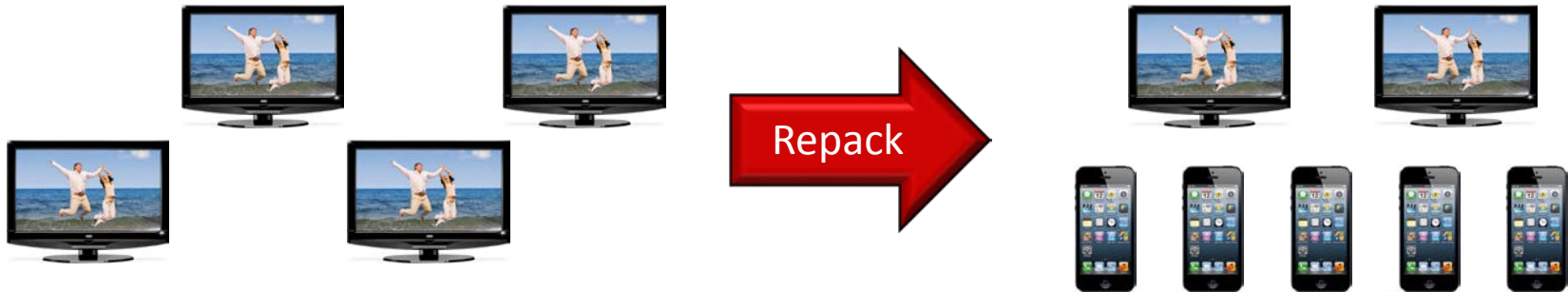

# Stations Affected

- 800 – 1200 stations are going to be impacted by the Repack
- This number will be determined by the amount of spectrum that will need to be cleared
  - 84 MHz will be channels 38 and above
  - 126MHz will be channels 30 and above, except channel 37 (protected)
  - These numbers were generated by the FCC, through the running of 100 different simulations

126	21	22	23	24	25	26	27	28	29	9	A	B	C	D	E	F	3	37	3	G	H	I	J	11	A	B	C	D	E	F	G	H	I	J	700 MHz UL
114	21	22	23	24	25	26	27	28	29	30	31	7	A	B	C	D	3	37	3	E	F	G	H	I	11	A	B	C	D	E	F	G	H	I	700 MHz UL
108	21	22	23	24	25	26	27	28	29	30	31	32	11	A	B	3	37	3	C	D	E	F	G	H	11	A	B	C	D	E	F	G	H	700 MHz U/L	
84	21	22	23	24	25	26	27	28	29	30	31	32	33	34	35	36	37	3	A	B	C	D	E	F	G	11	A	B	C	D	E	F	G	700 MHz U/L	

# Spectrum Auction Station Impact

## Data from FCC 120 MHz Clearing Target Repack Simulations

Eligible UHF Stations	1675	
Stations Eliminated	415	443
Stations Remaining on Channel (No Optimization)	71	92
Stations Required to Repack (No Optimization)	1147	1184
DTC Estimated Stations remaining on channel (After Optimization)	400	167
DTC Estimated Stations Required to Repack (After Optimization)	860	1065

## Data from FCC 84 MHz Clearing Target Repack Simulations

Eligible UHF Stations	1675	
Stations Eliminated	222	249
Stations Remaining on Channel (No Optimization)	92	132
Stations Required to Repack (No Optimization)	1361	1294
DTC Estimated Stations remaining on channel (After Optimization)	443	262
DTC Estimated Stations Required to Repack (After Optimization)	1020	1164

Sources: FCC DMA Simulations and DTC Analysis

\*\* The numbers above represent a range based on the analysis of the FCC 100 repack simulations

**800 to 1200 stations will need to rebuild transmission infrastructure as part of repack**



# Estimated Costs for Total Repack

## Total Cost Summary if 800 Stations are Repacked

Cost for Full Power Stations	\$ 996,554,020
Cost for Medium Power Stations	\$ 892,584,960
Cost for Lower Power Stations	\$ 31,480,000
Cost for Special Case Stations*	\$ 63,855,975
<b>Total Cost</b>	<b>\$ 1,984,474,955</b>

## Total Cost Summary if 1200 Stations are Repacked

Cost for Full Power Stations	\$ 1,495,187,804
Cost for Medium Power Stations	\$ 1,338,877,440
Cost for Lower Power Stations	\$ 47,220,000
Cost for Special Case Stations*	\$ 63,855,975
<b>Total Cost</b>	<b>\$ 2,945,141,219</b>

\* Represents shared sites with shared antennas such as 4 Times Square and Empire State Building in NYC, Wills and Hancock Towers in Chicago, Mt. Wilson in LA, and Mt. Sutro in San Francisco





# Repack Implementation Timeline

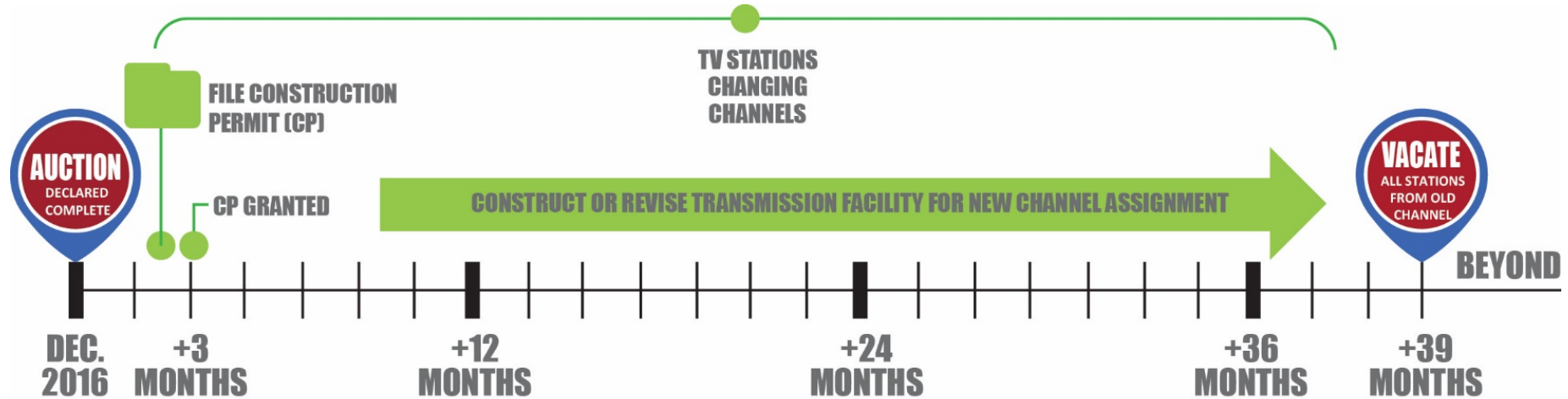

Recent regulations have stated that stations unable to make the transition within 39 months to their new channel will NOT be forced off the air

# An Auction on the Move – Timeline

Event	Current Estimate
Stations file <i>Application to Participate in Reverse Auction</i>	December 1, 2015 to January 4, 2016
Broadcasters make minor corrections and modifications necessary to complete their applications	January - March 2016
Deadline for broadcasters that registered for reverse auction to commit to preferred bidding option. This is a binding commitment to accept FCC's initial offer	March 29, 2016
FCC notifies each reverse auction applicant of their status. FCC runs initial clearing target optimization and sets initial clearing target	April – May 2016

# An Auction on the Move – Timeline

Event	Current Estimate
Reverse auction bidding rounds commence – bidding continues for about 1 month	May 2016
Forward auction is conducted. If revenues target not met, the FCC reruns the reverse auction with a lower spectrum target. If revenues are sufficient the auction closes, winning bidders, channel reassignments announced	June - September 2016
FCC commences payments to winning bidders on a rolling basis, as forward auction licenses are issued	November 2016

# An Auction on the Move – Timeline

Event	Current Estimate
Repacked stations must file construction permits (CPs) for new facilities and submit repacking cost estimates	December 2016 FCC set 90 day timeline to file CP applications following <i>Channel Reassignment Public Notice</i>
Station deadlines to build out CPs (station-specific deadlines)	February 2017 – December 2019
Filing window for displaced translators* Not protected, anyone displaced will hopefully be found a new space	August 2017
Deadline for repacking expense finalization and true-up process	September 2019
All repacked stations to be operating on new channels; all broadcasts on pre-auction channels end	December 2019

# What part of a TV facility is impacted?

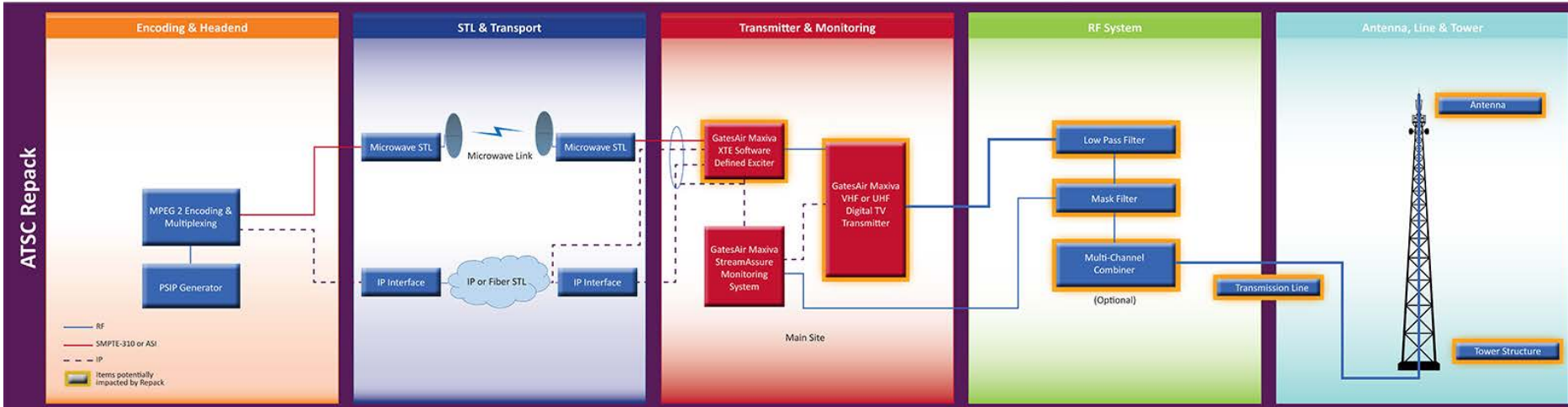

# Television Transmission System Impact

Likely to be affected:



Possibly affected:

- Transmitter, comprising:

- ✓ Exciter
- ✓ Amplifier
- ✓ Power Supplies
- ✓ Control
- ✓ Cooling System

- External RF Items:

- ✓ LPF / Mask Filter
- ✓ RF Combiner
- ✓ Patch Panel / Dummy Load
- ✓ Transmission line
- ✓ Antenna

ANTENNA

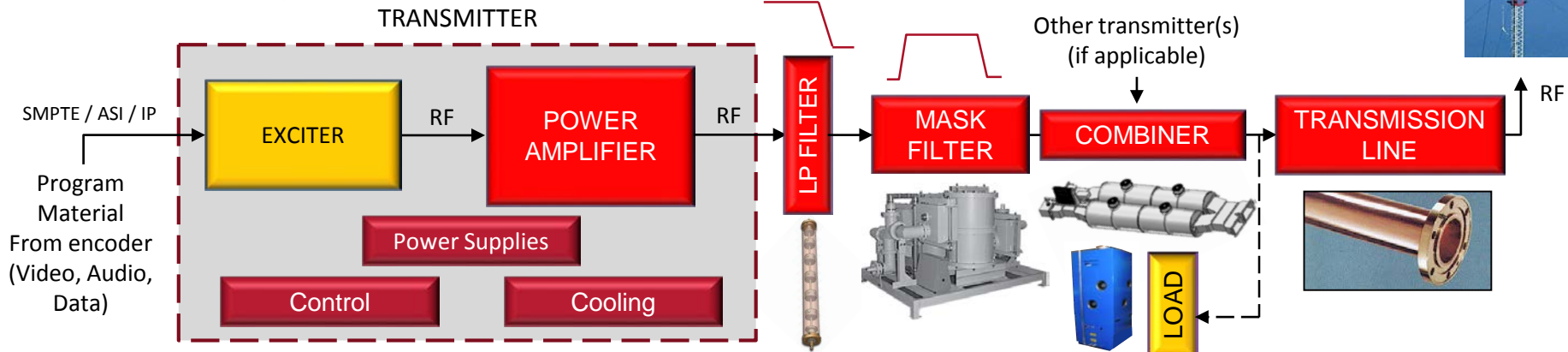

# FM and TV stations that share towers

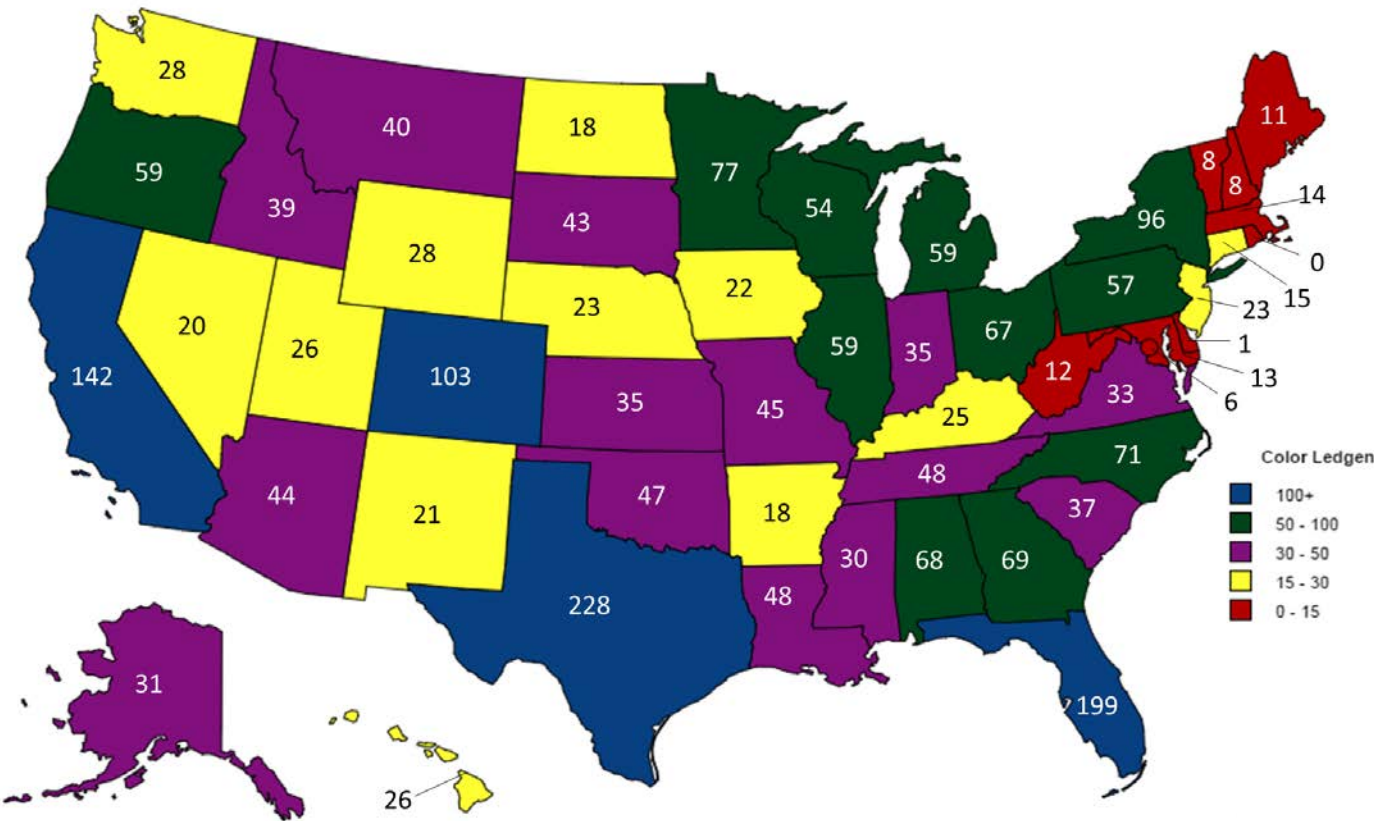

**TV & Radio** FCC data indicates **1153** towers in the US have both Radio and TV stations

**Radio** There are **2368** FM radio stations, or translators on TV towers that could be impacted by repack

**Full Power Radio** Over **1300** are full power FM

# Transmitter footprint – floor plan impact

- Flash cut scenario drive parallel operations
- New Transmitter needs significant space when RF system is included
- Liquid cooling system impact space both in and outside of the building
- Existing FM transmitters may need to be relocated for access or new transmitter space
- Electrical systems may need to be upgraded – off air interruptions

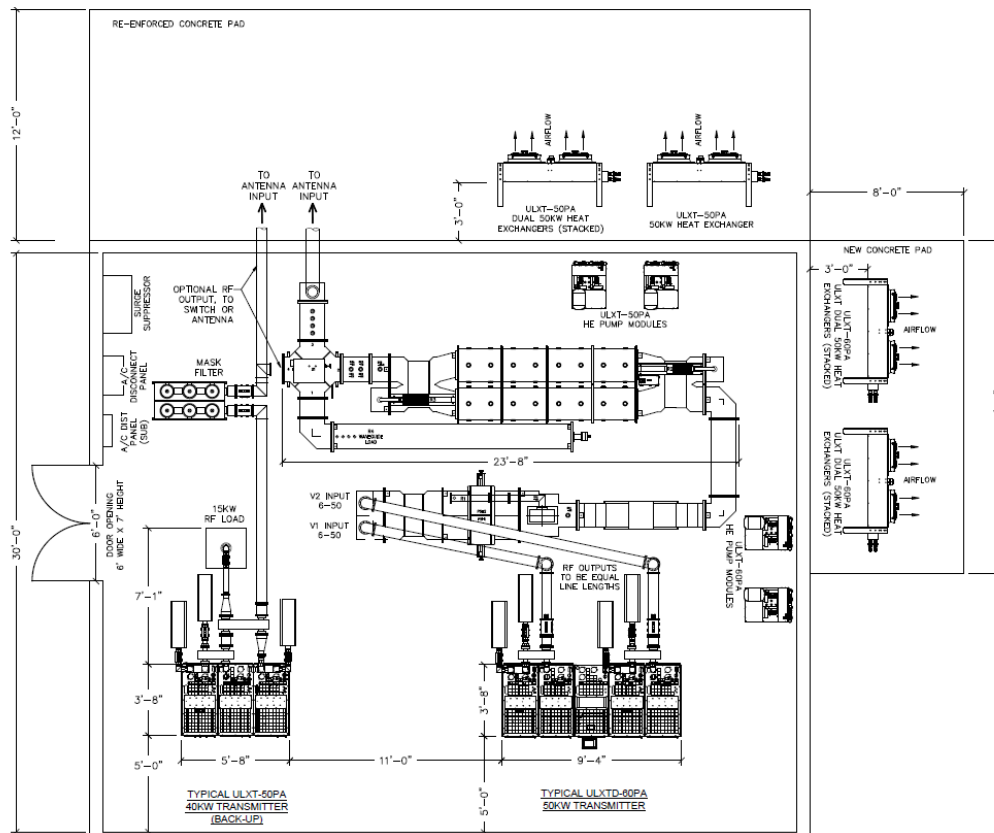



# New Side-mount Antenna is Likely

- Easy way to accommodate channel transition
- Long term operation (several months to a couple of years) is likely so full power / full gain side-mount will be preferred
- Tower Loading and possible re-enforcement will drive many decisions
- Required size for TV side mount may impact FM



# Tower Structural Analysis

- TIA-222 Rev G
  - Ice
  - Wind Speed
  - Topography
  - Shape Factors
- Tower owner will need to get a structural analysis

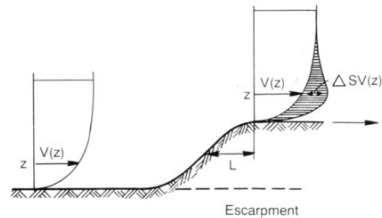
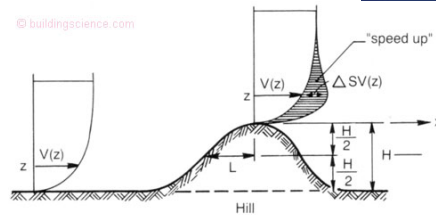

# Coverage Replication

- OET-69 “dipole factor”

Table 2

Field Strengths Defining the Area subject to Calculation for DTV Stations

Channels	Defining Field Strength, dBu, to be predicted for 50% of locations, 90% of time
2 - 6	28
7 - 13	36
14 - 69	$41 - 20 \log[615/(\text{channel mid-frequency in MHz})]$

$$P_r = P_t \frac{G_t G_r \lambda^2}{(4\pi R)^2}$$

1 MW ERP AT CH49 WILL BE ALLOCATED 687 KW ERP AT CH 25

# Replicate with Same Size Antenna

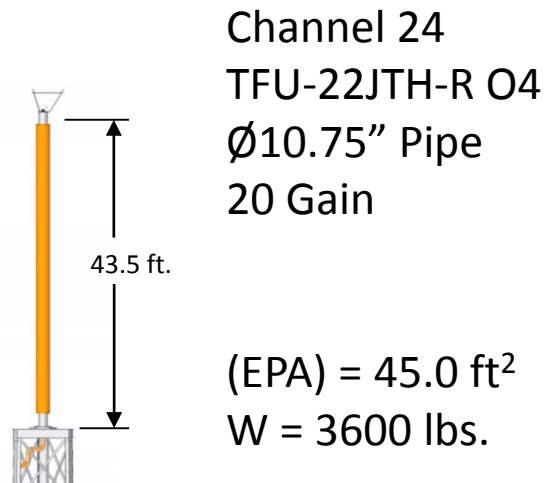
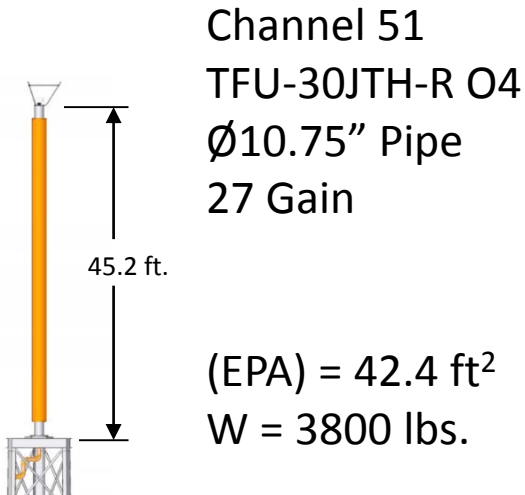

SAME SIZE AND WINDLOAD – LOWER GAIN

# Replicate with Same Gain Antenna

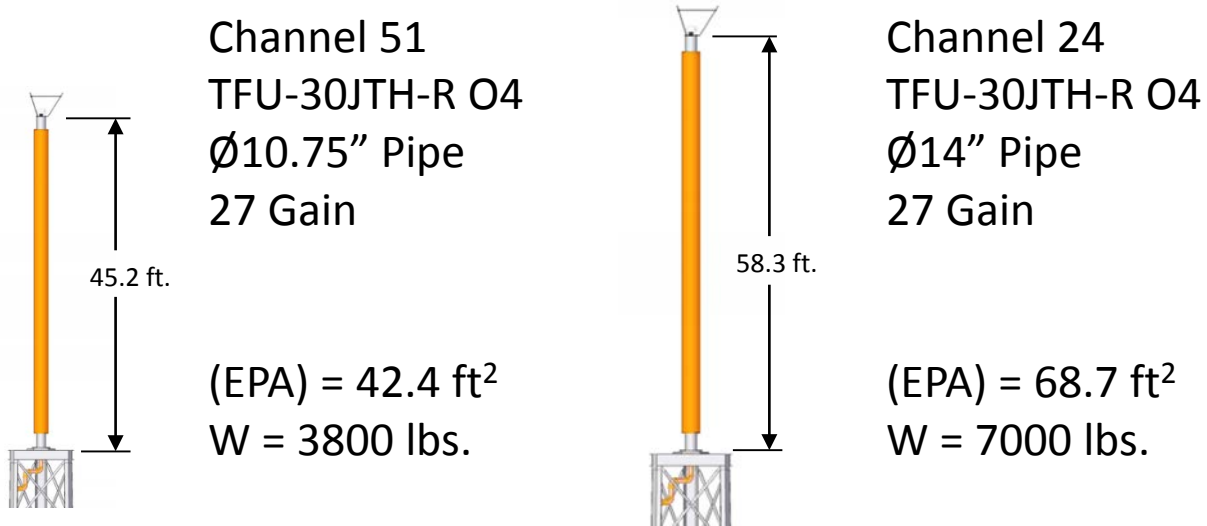

REQUIRES LARGER HEAVIER ANTENNA

# Site Density will Drive Impact to Radio

Lower Impact



Tall tower with open vertical space

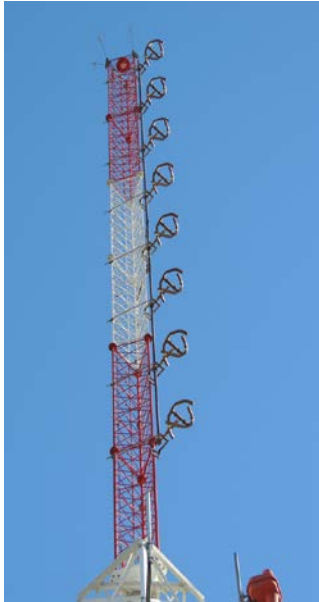

FM antenna is top mounted & TV antenna is side mounted

Higher Impact



Congested tower



Congested mountain top site or building supporting multiple towers and multiple stations

# Impact of an FM antenna move

- Vertical Polarization Pattern not effected—  
always broad cardioid
- H- pole pattern becomes directional with ~6'  
face size
- H-pole pattern becomes more omnidirectional  
with ~ 10' face size

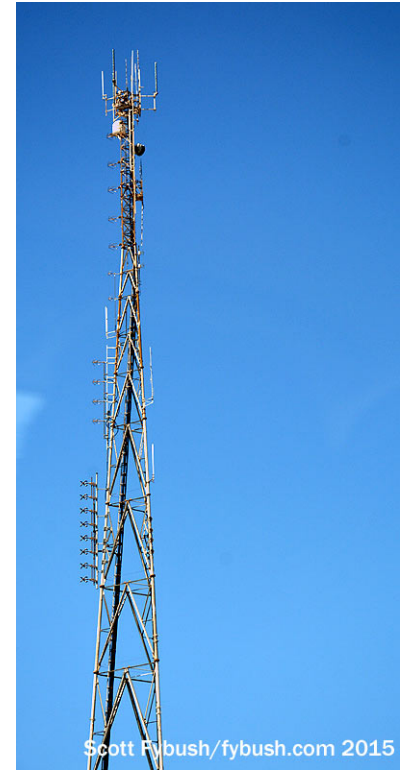

Scott Fybush/fybush.com 2015

# FM Pattern impacted by tower size

- Directional station would need to re-file with new pattern study

Both Antennas are leg mounted

DCRC on 24" Face Tower

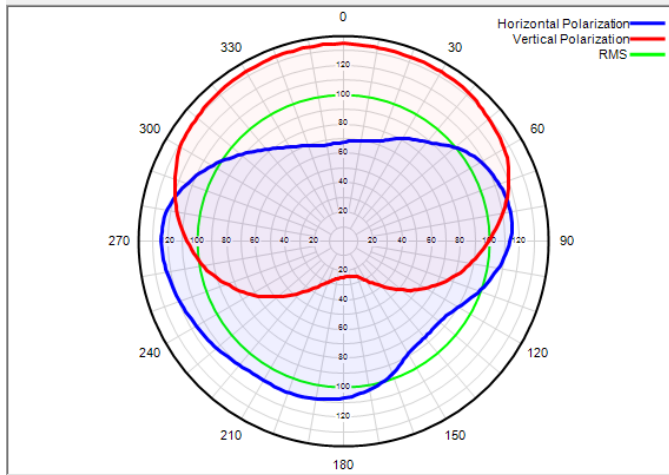

DCRC on 48" Face Tower

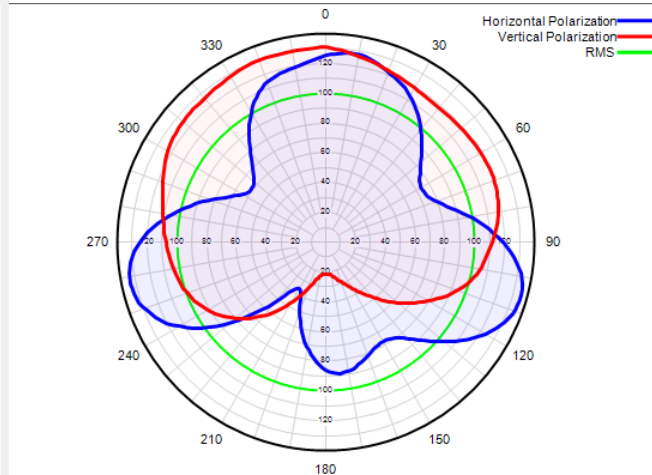



# Channel impacts transmission line

- In UHF ridged line length has VSWR impact base on frequency

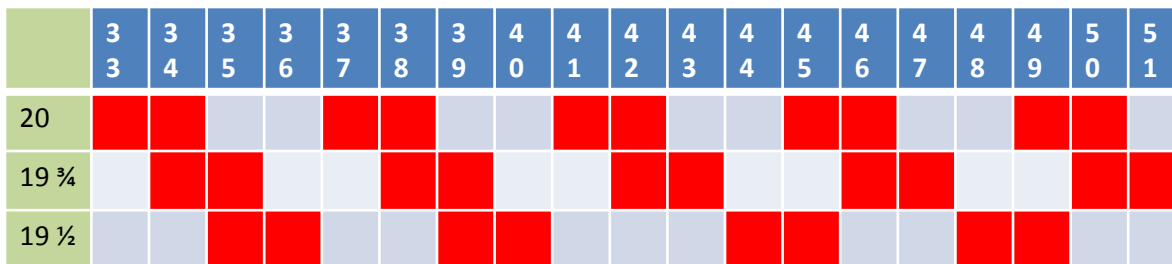
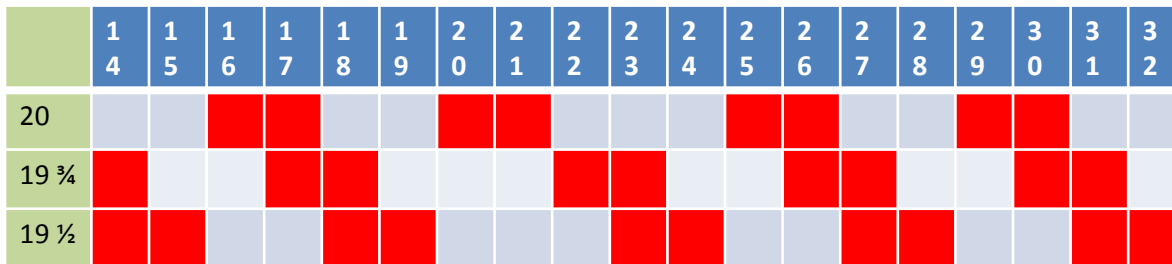

A move from CH 44 to CH 17 using 20' line lengths will need to replace transmission line



Prohibited Channel per catalog

# TV Relocates to VHF CH 6

- FM Antenna can receive channel 6
- Power from Channel 6 can Mix in output stage of FM transmitter
  - Important for transmitters to have good turnaround loss
- IM Power is rebroadcast onto upper upper-adjacent FM frequencies
- Only an issue with very low FM channels (88.1~90.1)
- Channel 6 Antenna needs to be close to FM antenna
- Actual requirement for filter depends on several factors—distance, azimuth and elevation patterns, FM transmitter turn around loss...

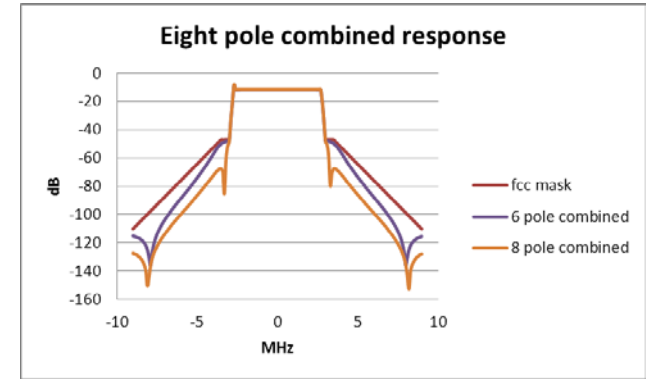

Four\_pole 88.1 - 2016/01/26 12:50:56

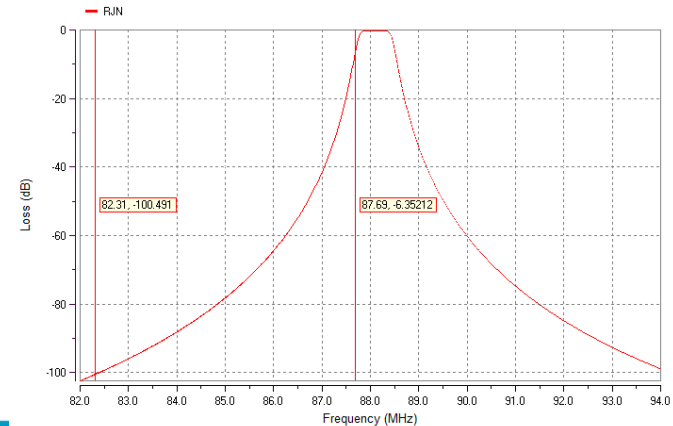

# Impact on Broadcast Technical Resources

- Large demand on consulting engineers time
- Structural analysis
- Transmitter installers
- Tower crews – new towers and antenna installation
- May impact planned Radio projects
- May need to look for alternative resources
- Projects may get delayed



# How does this impact the co located radio

## TV Station Change

- Antenna Change
- Transmission Line Change
- Tower Structural Reinforcement
- RF System Change
- Transmitter Change
- Electrical Service



## Impact On Radio Station

- Off air Time, may need to relocate
- Off air Time, may need to relocate
- Off air Time, may need to relocate
- In building floor plan changes – may need to move equipment
- In building floor plan changes – may need to move equipment
- Changes to Service may impact radio transmitter

Planning for site redundancy critical to avoid off air time

# Summary

- With over 2300 radio stations share facilities TV likely large impact
- Go see your neighbors – engage TV station soon
- Broadcaster transition fund is taken from auction proceeds
  - Paid to TV broadcasters involuntarily repacked to new channel
- Put together plan and budget if FM site is severely impacted
- Possible that impacted FM sites can re-coup costs due to TV channel change
  - FM costs must be considered in impacted TV stations budget
- Most severe resource constraints will be structural engineers, antenna supply, installation crews
- Most of all – Plan early and follow the Boy Scouts motto - Be Prepared

